



## PowerLED Downlight Installation and Operation Manual



## OVERVIEW

Imtra PowerLED fixtures are uniquely suited for marine, automotive, and architectural lighting applications. They have been engineered specifically to take advantage of the latest LED (Light Emitting Diode) technology offering superior reliability, minimal power consumption, and far less radiated heat than traditional incandescent light sources. When installed properly, these products will provide years of flawless performance.

All the downlights in this series are offered with a choice of LED color in addition to Bi-Color options. To take advantage of full dimming functionality, the Imtra Single and Dual Channel PowerLED PWM Dimmer must be used. Either dimmer provides the ability to dim both single color and Bi-Color lights on a single circuit. The 2-Channel model can operate two channels independently or in “paired” mode providing up to 14A capacity. The 2-Channel model also allows Bi-Color dimming with a single momentary switch!

We encourage you to read this installation guide thoroughly as there are particular electronic & electrical criteria and other critical installation details that should be met in order to assure many years of enjoyment from your new PowerLED product(s).

The Imtra PowerLED family of products is compatible with several Automated Control Systems. For more information on integrating our PowerLEDs with your control system, please contact us at 508-995-7000 or via email at [lighting@imtra.com](mailto:lighting@imtra.com).

## SPECIFICATIONS

|                                  | Wave   | Surf                      | Blade          | Carve                     | A-105           | A-155           |
|----------------------------------|--|---------------------------|----------------|---------------------------|-----------------|-----------------|
| Trim Ring Width                  | Ø 3.63" (92mm)                                 | 3.63" x 3.63" (92 x 92mm) | Ø 3.63" (92mm) | 3.14" x 3.14" (80 x 80mm) | Ø 4.13" (105mm) | Ø 6.10" (155mm) |
| Cutout                           | 2.65" (67mm)                                   |                           |                |                           | 3.39" (86mm)    | 5.36" (136mm)   |
| Actual Recessed Depth            | 1.06" (27mm)                                   | 1.05" (27mm)              | 1.09" (28mm)   | 1.05" (27mm)              | 1.53" (39mm)    | 1.35" (35mm)    |
| Recommended (min) Recessed Depth | 1.56" (40mm)                                   | 1.55" (39mm)              | 1.59" (40mm)   | 1.55" (39mm)              | 2.03" (52mm)    | 1.85" (47mm)    |
| Input Voltage                    | 10-40 VDC                                      |                           |                |                           |                 |                 |
| Power Consumption                | 4.7 Watts                                      |                           |                |                           |                 |                 |
| IP Rating                        | IP65* (Stainless Steel or White finishes only) |                           |                |                           |                 |                 |

\*The ingress protection rating applies only to frontal water exposure.

## PHYSICAL INSTALLATION

It is imperative that the lights are mounted in such a location that the fixtures are protected from the rear against water exposure.

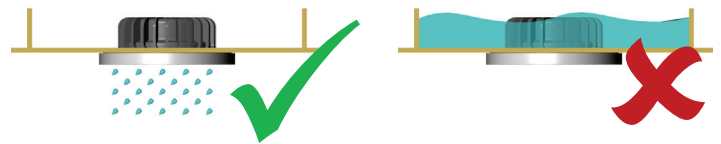

Also, it is important that the lights are mounted with airspace around the heat sink housing to allow for convective cooling of the lights. We recommend a distance of 1/2" (13mm) of free space above the housing.

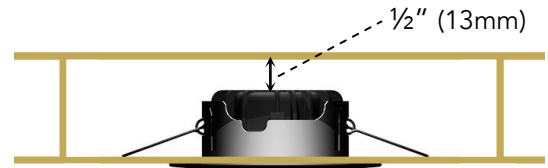

## INSTALLATION INSTRUCTIONS

1. Cut a circle in the mounting surface according to the cutout diameter required by your light (see chart on page 2).
2. Connect the light to a DC power source following the Wiring Instructions in the next section of this guide.
3. Once all electrical connections are made and secure, gently bend back the mounting springs of your PowerLED and insert the spring tips into the cutout circle in the mounting surface (see Figure 1).
4. Gently push the light into the mounting hole allowing the springs to come to rest on the inside of the surface, holding the light in place (see Figure 1).

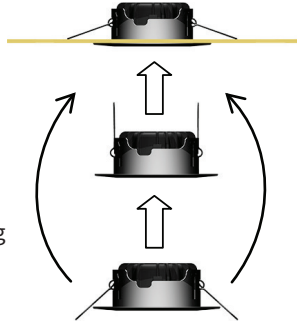
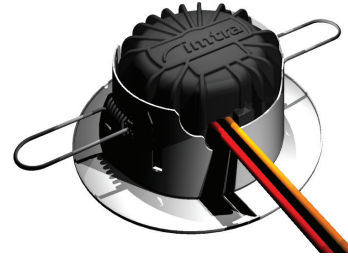

Figure 1

- 4 -



| Wire   | Function        |
|--------|-----------------|
| Red    | + (white light) |
| Black  | -               |
| Orange | + (color light) |

## NOTES ON WIRE SIZE

The PowerLED family of products comes equipped with integrated driver electronics. These components are sensitive to DC systems with voltage drops. Therefore, it is imperative to select the correct wire size to supply DC voltage to the lights. This prevents excessive impedance and voltage drops which can cause premature failure in the PowerLEDs. It is recommended that the supply wire size be selected according to the ABYC Wiring Recommendations Chart for a 10% voltage drop. These charts can be found at [www.imtra.com](http://www.imtra.com).

- 5 -

## WIRING INSTRUCTIONS (No Dimmer)

1. Connect the light to a DC power source. Connect the red wire to positive DC voltage and the black wire to negative or ground.
2. If you are installing a Bi-Color PowerLED product, the orange wire should be connected to switched positive DC Voltage.

## WIRING INSTRUCTIONS (with Dimmer) for PWM digital, 0-10V or 4-20MA analog control inputs

Please refer to the Installation Manual that is included with your Imtra 1-Channel or 2-Channel PowerLED PWM Dimmer or go to [www.imtra.com](http://www.imtra.com) and download the manual from there.

- 6 -

### Wiring Diagram

- Single Color Units
- No Dimming
- Single Switch Location

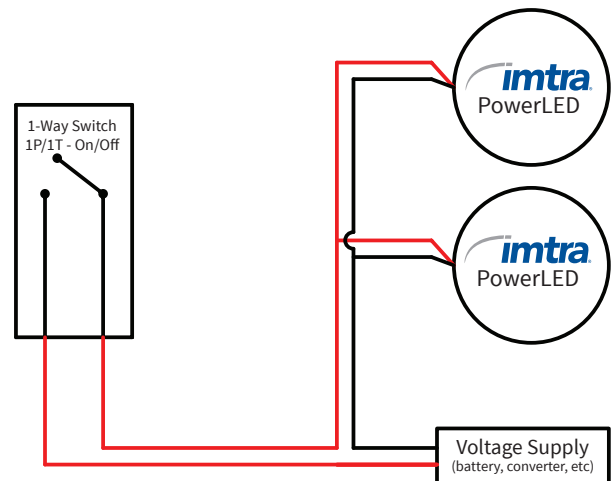

- 7 -

### Wiring Diagram

- Single Color Units
- No Dimming
- Multiple Switch Location

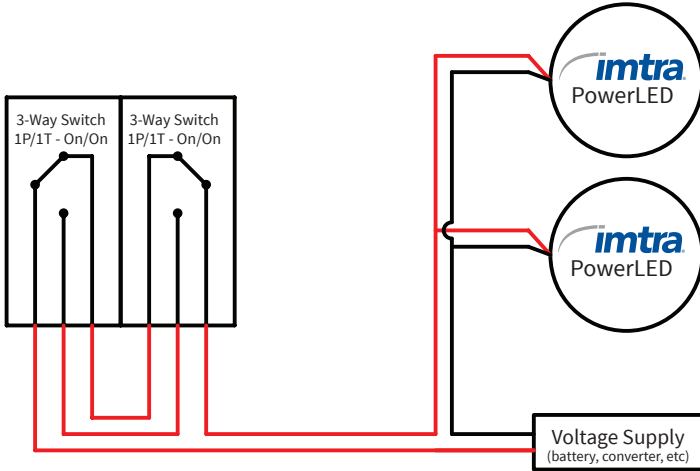

- 8 -

### Wiring Diagram

- Bi-Color Units
- No Dimming

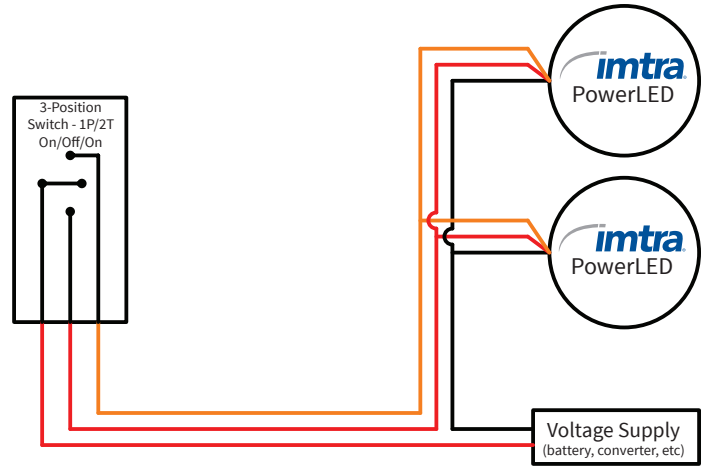

- 9 -

## LIMITED WARRANTY

Imtra warrants the light-emitting LSA (LED subassembly) component of our IML PowerLED spot lights & fixtures for 5 years from the date of purchase. If the LSA should cease to function within 5 years, return the complete spot light assembly to Imtra for repair or replacement.

This warranty does not apply to damage resulting from actions of the user such as misuse, improper wiring/installation, operation outside of specification, improper maintenance or repair, unauthorized modification, lightning strike or damage from a power surge.

The trim ring (bezel) of the IML Power LED spot lights are warranted for one year.

Imtra specifically disclaims any implied warranties, merchantability or fitness for a specific purpose and will not be liable for any direct, indirect, incidental or consequential damages. Imtra's total liability is limited to repair or replacement of the product.

The warranty set forth above is inclusive and no other warranty, whether written or oral, is expressed or implied.

If it should become necessary to return a fixture for service during or beyond the warranty period, please refer to Imtra's standard Return Policy as detailed on Imtra's website ([www.imtra.com](http://www.imtra.com)) or call Imtra customer service at 508-995-7000.

No returns are accepted without a Return Authorization (RA) number.

- 10 -



30 Samuel Barnet Boulevard, New Bedford, MA 02745  
(508) 995-7000 • [www.imtra.com](http://www.imtra.com)